

XOMOX[®]

brands you trust.

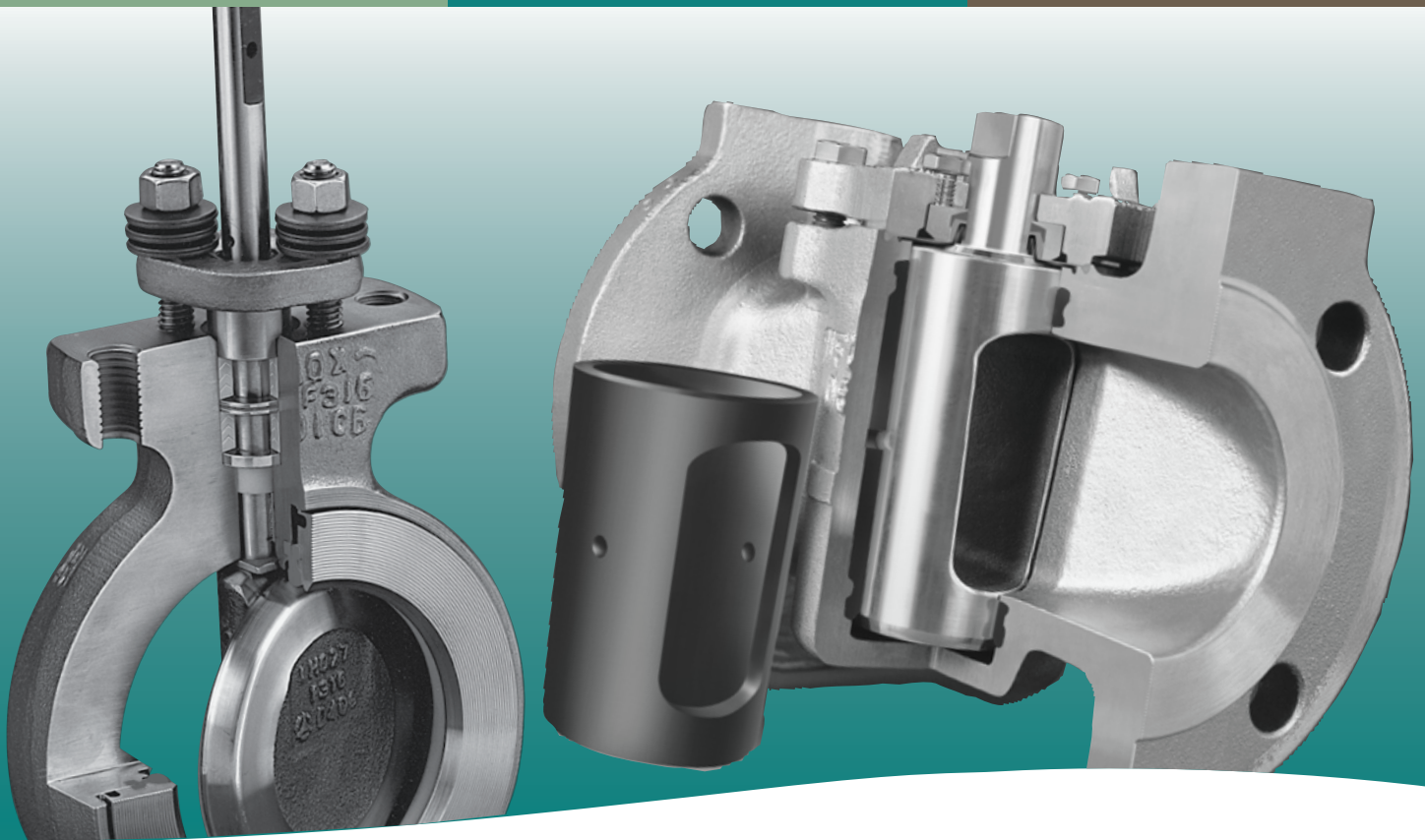

Tuflin[®] **XENITH[™]** Extended Temperature Valves

CRANE

ChemPharma Flow Solutions

www.cranepharmasolutions.com

The XENITH Family of Valves



The valves in the XENITH family of products share a proprietary and innovative seal material that makes them the ideal choice for a wide range of applications in any industry demanding seal integrity at temperatures up to 600°F. The seal material they have in common is a chemically inert fluoropolymer called **Tuflin-600**.

The **XENITH XT Sleeved Plug Valve**, the **XENITH XT Soft-Seated High Performance Butterfly Valve**, and the **XENITH XT Metal Seated High Performance Butterfly Valve** all use Tuflin-600 as a sleeve, seat, seat insert, or other sealing member. The use of Tuflin-600 allows a **XENITH** valve to maintain a tight seal at temperatures up to 600°F; a 50% increase over the traditional soft seated PTFE temperature limit of 400°F, enabling a **XENITH** valve to exceed performance expectations in extreme conditions in virtually every measure.

www.xomox.com

Xomox®, Tuflin® & Matryx® are registered trademarks of Xomox Corporation. Cincinnati, Ohio U.S.A.

XENITH™ and XRPT™ are trademarks of Xomox Corporation. Cincinnati, Ohio U.S.A.

All rights reserved. © Copyright 2000, 2009

Benefits of Tufline®-600

ENHANCED STRENGTH AND RESISTANCE TO ABRASION AND WEAR

In addition to exceptional performance in extreme temperatures, the unique formulation of the Tufline-600 assures long-term reliability with the most difficult and abrasive flow media.



STRUCTURAL INTEGRITY AT ELEVATED TEMPERATURES

PTFE is both viscous and elastic at all temperatures, making it susceptible to viscoelastic deformation – flow and creep - under load.

Tufline-600 minimizes concerns about creep and deformation under load at elevated temperatures.



REDUCED COLD-FLOW AT ELEVATED TEMPERATURES

Increasing pressures and temperatures can cause cold-flow, or viscoelastic deformation of standard PTFE.

Under extreme conditions PTFE sleeves can extrude into the flow-path of a valve, preventing it from operating properly. Tufline-600 outperforms standard PTFE, reducing cold-flow by a margin of more than 2:1.



BELOW IS A PARTIAL LIST OF THE INDUSTRIES AND APPLICATIONS UTILIZING XENITH™ VALVES:

MINING:

Steam
Ore Leaching
Mineral Slurries
Autoclaves
Trona Slurry
Sodium Carbonate
Carbonic Acid

REFINING:

HF Acid
Steam
Light Hydrocarbons

FOOD:

Steam Peelers
Hot Vegetable Oil

PLASTICS:

Resins
Polymers

CHEMICAL:

Hot Acids
Sodium Hydroxide
Chloroform
Chlor-pyridene
TDA

TIRE MANUFACTURING:

Steam

GENERAL:

Hot Air
Heat Transfer Fluids



Tufline XENITH™ XT Sleeved Plug Valve

FEATURING THE TRIPLE TOP SEAL

- The Tufline XENITH XT Sleeved Plug Valve offers bi-directional flow, simple actuation, and lightweight and compact design in a variety of 2-way and multi-port configurations. This versatility expands the range of possibilities when designing a new processing system or improving an existing system.
- Xomox innovative Tufline-600 sleeve completely surrounds the plug, providing a large, circumferential sealing surface from port to port for superior, long-lasting in-line sealing. Open, closed or rotating, the seal is assured - no seizing or sticking as the plug rotates.
- The valve's Tufline-600 sleeve is self-lubricating and self-cleaning. Its 360 degree lips remove scaling and adhering media that could impede rotation of the plug.
- The valve's Tufline-600 sleeve, with its enhanced stability and resistance to cold-flow assures sleeve integrity. No sleeve rotation can occur and blow out is greatly minimized.
- The valve's cavity-free design virtually eliminates potential contamination because there is no place for flow media to accumulate.

XENITH™
600°F

Benefits of the Triple Top seal

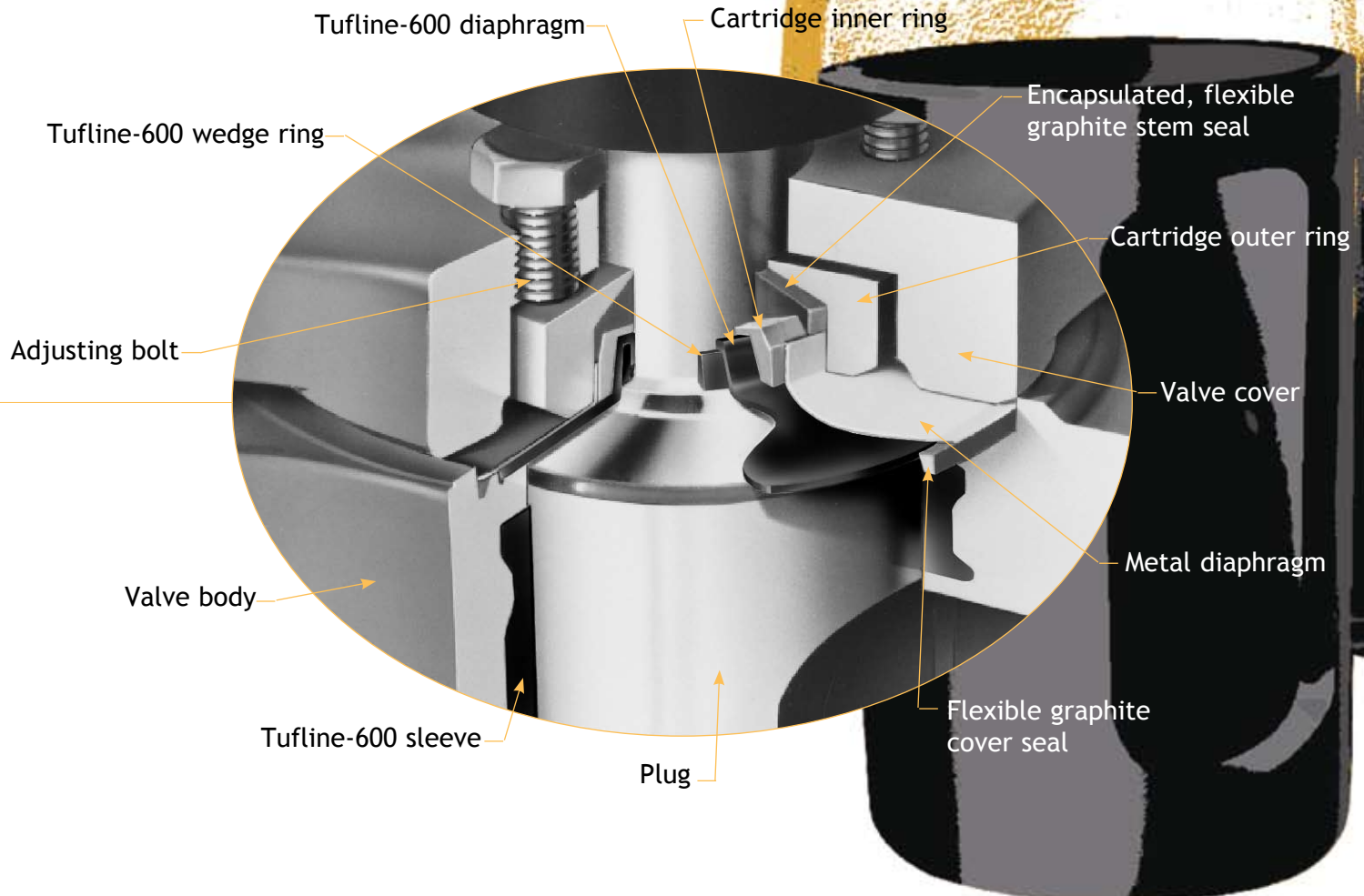

For demanding applications, the Tufline XENITH XT Sleeved Plug Valve provides three sealing systems between the flow media and atmosphere. Primary, secondary and tertiary seals provide redundant protection against external stem leakage, assuring a long service life with less required maintenance.

1. The primary in line, as well as external seal results from the interaction of the plug, the circumferential sealing surface of the Tufline-600 sleeve, and the valve body. In the closed position, the in-line seal is bubble tight. This is an important safety consideration.
2. The secondary seal is provided by the Tufline-600 and metal diaphragms.
3. At the stem the tertiary seal is provided by the fully encapsulated, flexible graphite stem seal.

4. At the body-to-cover joint the tertiary seal is provided by the graphite cover seal ring.
5. Easily accessible adjustment bolts assure tight internal and external sealing.
6. The simple, unique external sealing system means there is no elongated bonnet. There are also no elaborate, expensive, external add-on devices required to control fugitive emissions.

Pressure Temperature Ratings for XENITH™ Plug Valves

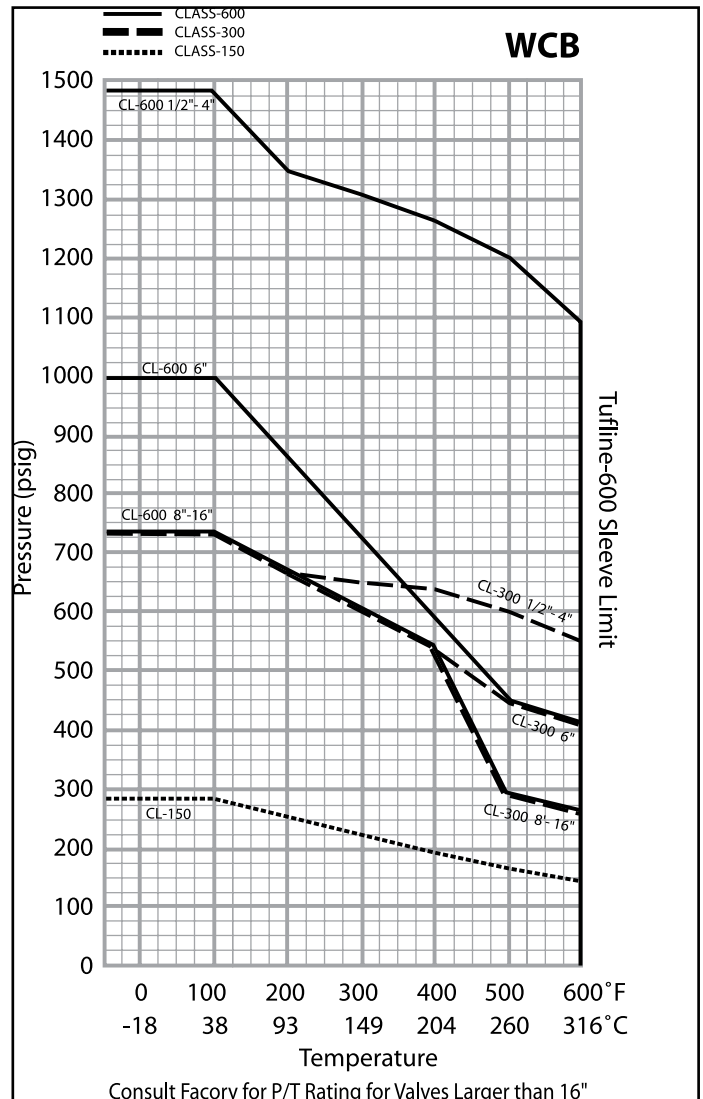
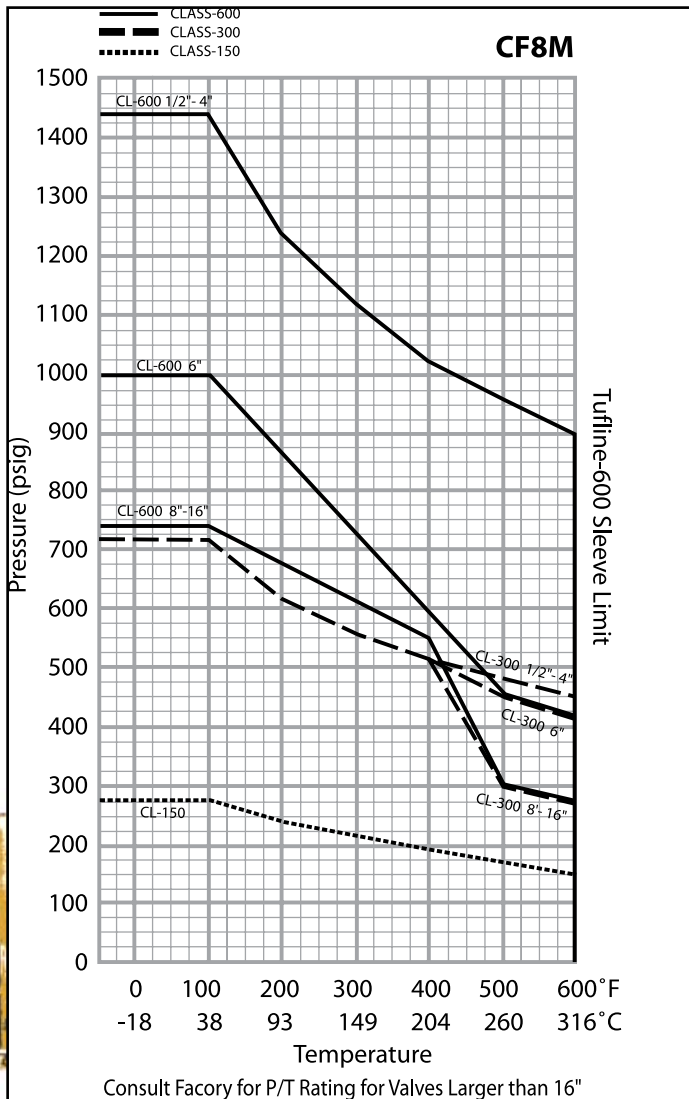

The useful range of Tuflin-600 is -20° F to 600° F with a maximum temperature variation of 200° F.

AVAILABILITY

- ANSI Classes 150, 300, & 600
- Sizes from 1/2 inch through 24 inches
- Screwed, flanged, and weld end connections are standard, others available
- Reduced and full port designs
- 2-way and multiport
- XP Design
- A wide variety of body and plug materials are available

VALVE TORQUE

To calculate the torque of a standard reduced port XeniTh plug valve add 35% to the standard PTFE sleeved plug valve torque as noted in catalog 329703. To calculate the torque of a standard full port XeniTh plug valve add 100% to the standard PTFE sleeved plug valve torque as noted in catalog 329730.

HOW TO SPECIFY

Size Figure No. Option Body Plug Sleeve Operator Service
1" - 066 - XT - FT - 6 - 6 - P20 - TS - W - C

SIZE AND FIGURE NO.

OPTIONS

Fire TestedFT
 Cage ControlCCV
 Extended PackingXP
 Partial JacketPJ
 Full JacketFJ

Port Arrangements for 3-way valvesA, AX, C, or D

Valve specifications may include multiple options.

BODY

Alloy 200
 Ductile iron1
 Carbon steel2
 Monel3
 304 SS4
 Nickel5
 316 SS6
 Hastelloy B8
 Hastelloy C9
 CD4MCU27
 Inconel40
 Other (specify).....X

* Specify actuator type and available air supply.

** Consult your Xomox Sales Engineer for a wide variety of other available service options.

SERVICE

ChlorineC
 OxygenO
 VacuumV
 General ServiceBlank
 Other**..... X

OPERATOR

Less OperatorN
 WrenchW
 Wrench with locking device...WY
 GearG
 Gear with locking deviceGZ
 Actuator*A

SLEEVE

Tufline-600

PLUG

Alloy 200
 Monel3
 304 SS4
 Nickel5
 316 SS6
 Hastelloy B8
 Hastelloy C9
 CD4MCU27
 Inconel40
 Other (specify).....X

PRODUCT RESPONSIBILITY

Crane Co., and its subsidiaries cannot accept responsibility for possible errors in catalogues, brochures, other printed materials, and website information. Crane Co. reserves the right to alter its products without notice, including products already on order provided that such alteration can be made without changes being necessary in specifications already agreed. All their trademarks in this material are property of the Crane Co. or its subsidiaries. The Crane and Crane brands logotype (Xomox®, Saunders®, Resistoflex®, Resistopure™, PSI®, DEPA®, ELRO®, REVO®) are registered trademarks of Crane Co. All rights reserved.

Tufline XENITH™ XT Soft Seated HPBV Valve

FROM THE XOMOX SPECIAL PRODUCTS GROUP

Because it utilizes Tufline-600 seal material, the Soft-Seated XENITH HPBV provides a virtually leak proof seal and an extended service life in temperatures up to 600° F.

The valve's Tufline-600 seat is axially pliant. Unlike other seals, there is no radial stretch, so when the valve opens, the seat flexes axially, returning to its original compact shape. It does not "relax" into the flow path.

This seat design includes two components:

- An outer portion made from Tufline-600
- A deformation-resistant, memory-core membrane.

The valve's Tufline-600 seat is simple - no springs, no O-rings, and no metal hoops - so there's no worry about breakage, swelling or corrosion. Because of its symmetrical shape, installation of the seat is simple and mistake proof.

DOUBLE OFFSET AND ECCENTRIC DISC MOUNTING EXTENDS SEAT LIFE, REDUCING MAINTENANCE COSTS AND DOWNTIME.

Seats last longer and maintenance is reduced because the eccentrically mounted disc minimizes seat deformation and wear.

DESIGN DRAMATICALLY REDUCES SEAT DEFORMATION AND WEAR.

When the Tufline valve opens, the eccentrically mounted disc moves with a cam-like action. The disc lifts away from the Tufline-600 seat, preventing seat deformation. Because friction between the disc and seat is virtually eliminated, the Tufline seat provides a greatly extended service life and reduced operating torque requirements, so smaller and more economical actuators can be used.

INTERNAL STOP PROTECTS AGAINST SEAT DAMAGE FROM DISC OVER-TRAVEL.

In XENITH butterfly valves, disc over-travel is limited, and the seat is protected through the use of a positive internal stop. Conventional valves that have no internal stop are subject to possible seat and disc damage from an improperly adjusted actuator.

In a XENITH hpbv, the shaft and disc are securely pinned, eliminating lost-motion, increasing control and making for easier maintenance. The pins are tapered, as are the sleeves, eliminating the need for matched drilling. The tapered sleeve and pins make replacement of the disc or shaft economical because they do not require matched drilling



FIGURE 1.

Valve closed, with right to left flow.

The axial movement of the seat in the direction of the flow produces a simple, leak-tight seal. Because it is pressure-assisted, the seal tightens as line pressure increases. Tight shutoff is maintained at temperatures up to 600°F.

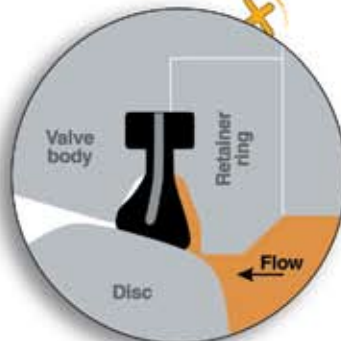

FIGURE 2.

Valve closed, with left to right flow.

Bi-directional flow and shutoff are easily accommodated. The same, simple, axial movement of the seat assures a reliable seal in either direction.

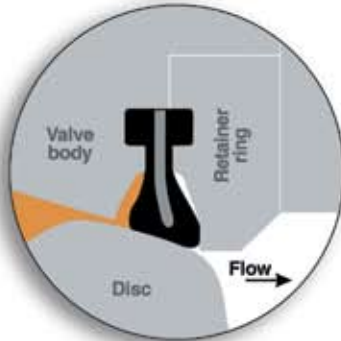
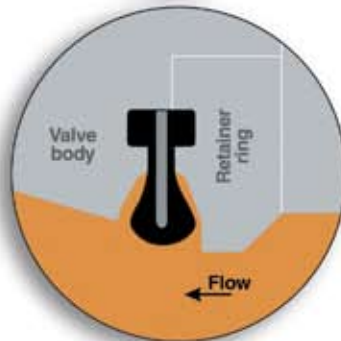

FIGURE 3.

Valve open, with media flowing.

Even after many cycles the seat maintains a tight seal. The seat's internal pliant membrane is the "memory core" that precludes radial deformation. To extend seat life, the inside diameter of the retainer ring is smaller than that of the Tufline-600 seat. This protects the seat from erosion and abrasion.



Tufline XENITH™ XT FT Seated HPBV Valve

FROM THE XOMOX SPECIAL PRODUCTS GROUP

SOFT-SEAT SEALING WITH METAL BACK-UP

For applications involving high temperature media, the dual component seat offers both the superior sealing properties of Tufline-600 and the security of a metal back up seal. The metal component is available in a variety of alloys.

- Graphite rope packaging
- Metal seat component
- Tufline-600 seat component
- Metal-to-metal seal
- Tufline-600-to-metal seal
- Metal-to-metal seal

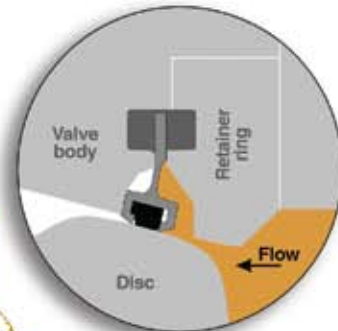
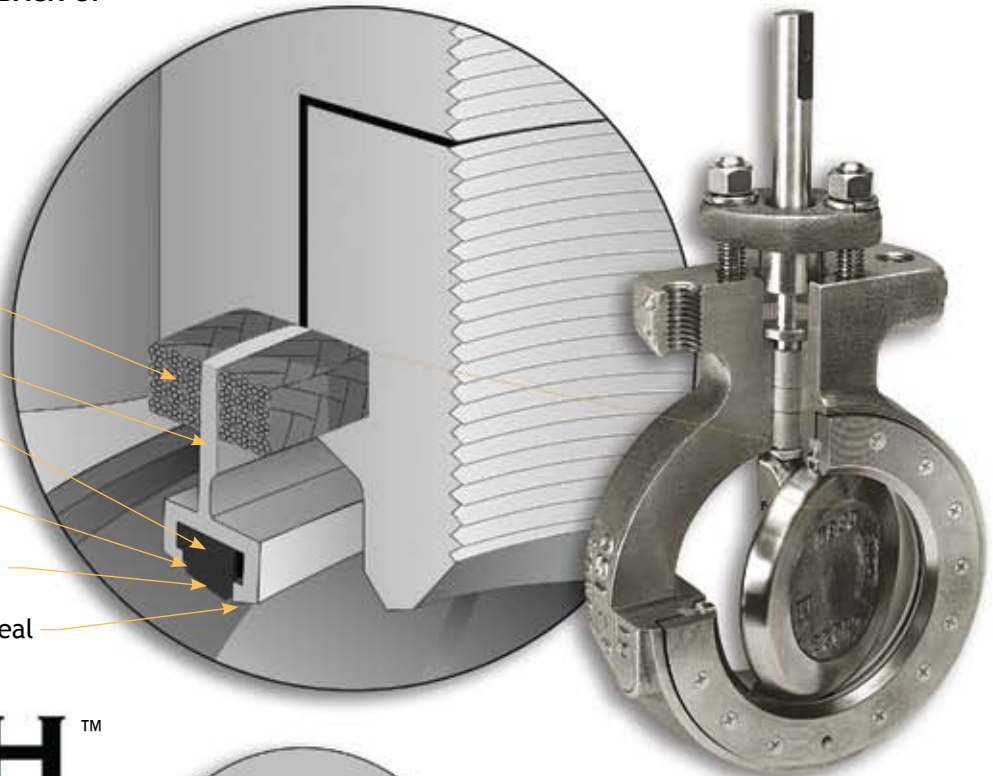

FIGURE 1.

Normal operation - right to left flow.
As pressure increases, the seat shifts axially in the direction of the flow. This tightens the seat contact with the disc for sure sealing.

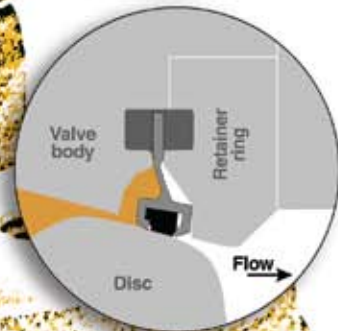

FIGURE 2.

Normal operation - left to right flow.
Non -Alternating
Both the metal seat and the Tufline-600 seal are in tight contact with the disc. As line pressure increases, the seal tightens, axially.

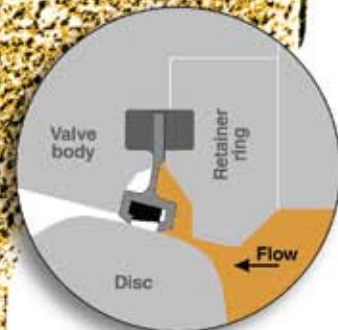
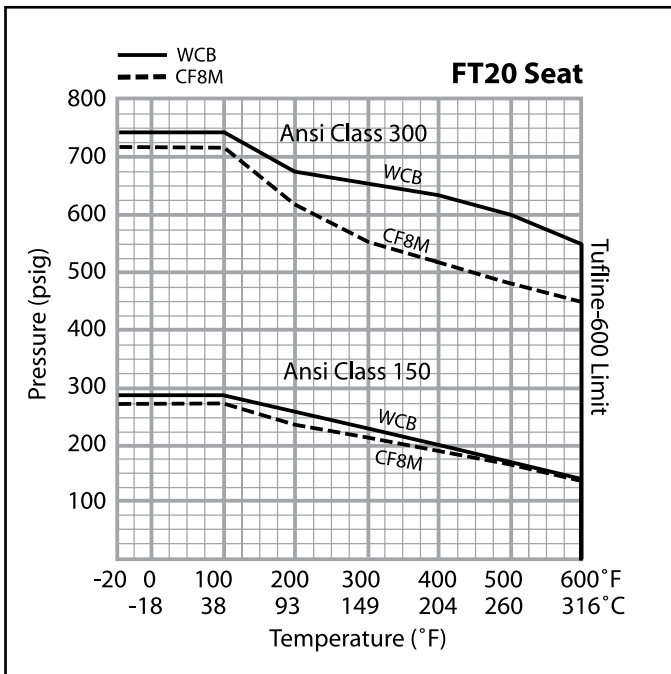
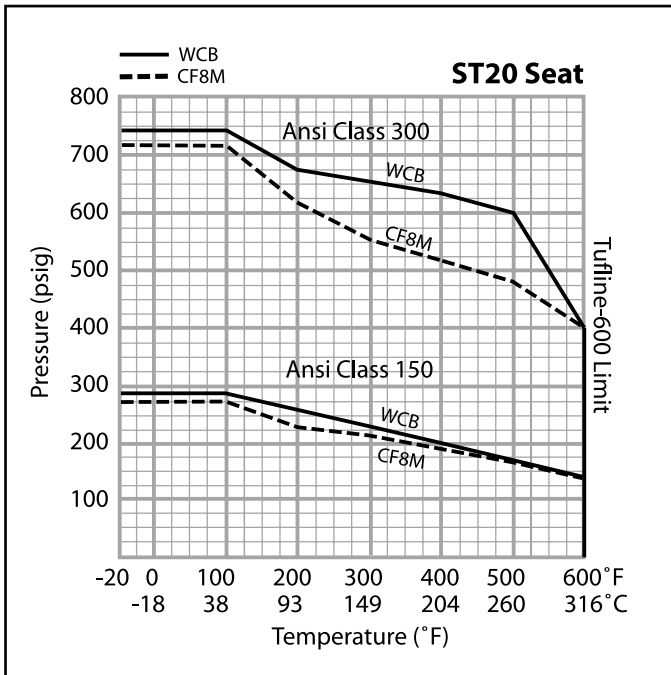

FIGURE 3.

High temperature upset condition.
In an upset condition, as the Tufline-600 portion of the seat deteriorates, the metal portion of the seat maintains the integrity of the seal. There is no interruption of the seal.

Pressure Temperature Ratings for XENITH™ High Performance Butterfly Valves



WARNING

For bidirectional dead end service, you must use body type 820, 821, or 823 valves. These valves have retainers specially designed for such service. Use of body type 810, 811, or 813 valves in such service will result in massive leakage.

GENERAL NOTES:

API 609 face to face dimensions are standard. Any other face to face requirements must be specified.

Consult factory for ΔP limitations on shaft materials other than 17- PH.

For sizes and materials not shown, consult factory

VALVE TORQUE

ST20: To calculate the torque of an ST20 seated XENITH HPBV use a 2.0 multiplier on the standard ST2 seat torque for temperatures up to 400 °F. For applications from 400 °F to 600 °F use a 1.2 multiplier on the standard ST2 seat torque.

FT20: To calculate the torque of an FT20 seated XENITH HPBV use a 1.2 multiplier on the standard FT1 seat torque for temperatures up to 600 °F.

(Reference catalog 329389 for ST2 and FT1 seating torque.)



XENITH "ST" and "FT" HPBV's are available in ANSI class 150 and 300 designs in sizes 2" thru 24". Lug and wafer designs in wide variety of body and disc materials are available. Operating temperatures up to 600 °F.

HOW TO SPECIFY

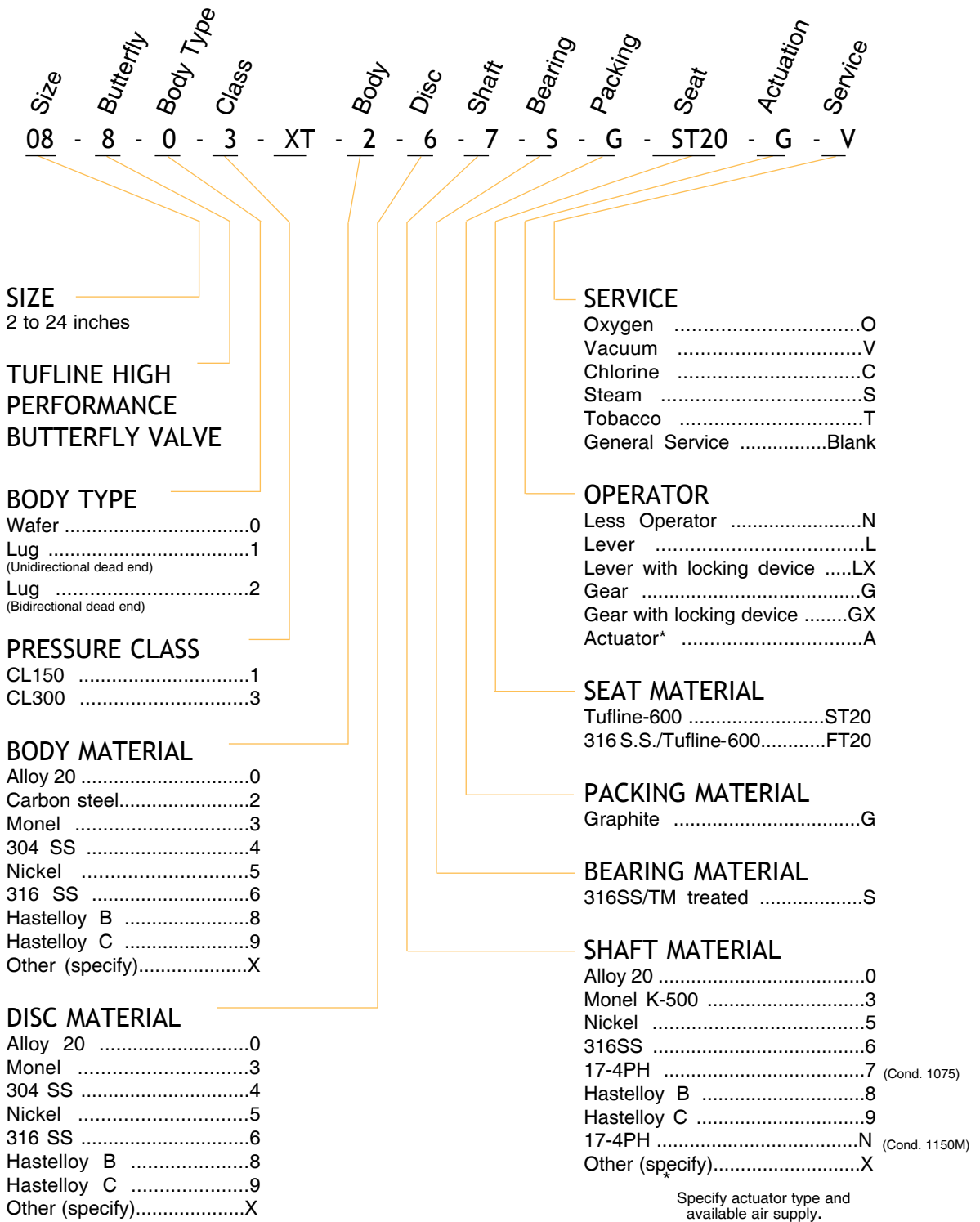

PRODUCT RESPONSIBILITY

Crane Co., and its subsidiaries cannot accept responsibility for possible errors in catalogues, brochures, other printed materials, and website information. Crane Co. reserves the right to alter its products without notice, including products already on order provided that such alteration can be made without changes being necessary in specifications already agreed. All their trademarks in this material are property of the Crane Co. or its subsidiaries. The Crane and Crane brands logotype (Xomox®, Saunders®, Resistoflex®, Resistopure™, PSI®, DEPA®, ELRO®, REVO®) are registered trademarks of Crane Co. All rights reserved.

XOMOX®

CRANE ChemPharma Flow Solutions™

XOMOX Headquarters
4444 Cooper Road,
Cincinnati, OH 45242, U.S.A.
Tel.: (513) 745-6000
Fax: (513) 745-6086

XOMOX International GmbH & Co. OHG
Von-Behring-Straße 15,
D-88131 Lindau/Bodensee
Tel.: (49) 8382-702-0
Fax: (49) 8382-702-144

CRANE

ChemPharma Flow Solutions



brands you trust.

CRANE ChemPharma Flow solutions Include: Pipe - Valves - Fitting - Actuators - Pumps

DEPA®

PSI
LINE PIPE SYSTEMS

ResistoPure

Saunders®
the science inside

ELRO®

RESISTOFLEX®

revo®

XOMOX®

CP-XOMOX-XENITH-BU-EN-CI-5/09-PN334251

Crane Co., and its subsidiaries cannot accept responsibility for possible errors in catalogues, brochures, other printed materials, and website information. Crane Co. reserves the right to alter its products without notice, including products already on order provided that such alteration can be made without changes being necessary in specifications already agreed. All their trademarks in this material are property of the Crane Co. or its subsidiaries. The Crane and Crane brands logotype (Xomox®, Saunders®, Resistoflex®, Resistopure™, PSI®, DEPA®, ELRO®, REVO®) are registered trademarks of Crane Co. All rights reserved.